

# Right Connections

towbar wiring kits for the uk

## BMW

**1 Series F40**

**09/2019 >>**

**Part No: BW-027-07M**

**2 Series Gran Coupé F44**

**03/2020 >>**

## Electric wiring kit for towbars / 7-pin / 12N / 12 Volt / ISO 1724 Fitting instructions

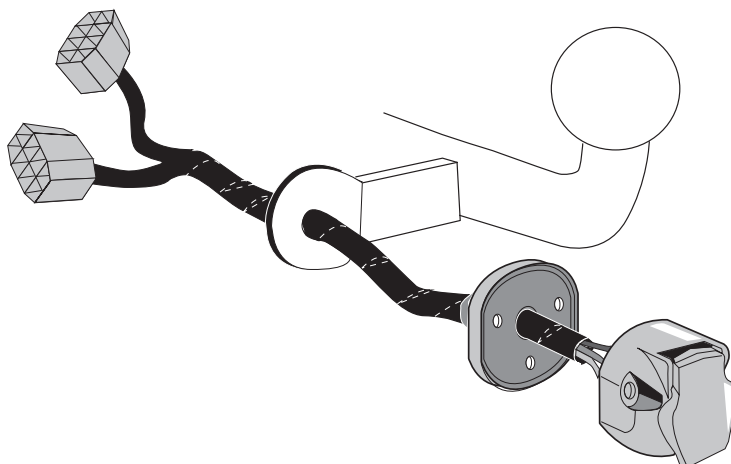

### IMPORTANT!

This electric kit has to be installed by a professional workshop or a suitable qualified person.

The installation instructions must have been read and fully understood before the start of any installation. Please contact your wiring kit provider or the hotline shown in the footer should you need assistance!

Make sure the vehicle is approved/homologated by the manufacturer to tow a trailer!

Also please check that there is a definite compatibility between this vehicle and the electric kit!

Following the installation of the electric kit, the fitting instructions should be kept together with the vehicle service document and vehicle handbook. The fitting instructions contain important information relating to the use and function of the towing kit as well as for any diagnostic or activation process, that might have to be repeated in the future (e.g. after the performance of a vehicle software update).

All warranty claims will be forfeited if the electric kit or components contained therein are used incorrectly or modified. If a towing socket adaptor has been used to connect to the trailer or bike rack, this must be removed from the trailer socket once the trailer or bike rack has been disconnected.

If the trailer or bike rack is not equipped with a rear fog lamp, depending on the towing vehicle type, the correct function of the towing kit cannot be guaranteed. In such cases, a rear fog lamp should be retro fitted.

This towing electric kit will not be covered under warranty if any technical or electrical modifications or software updates have been performed by the vehicle manufacturer after the initial commissioning of the kit. That applies especially to modifications or updates which may cause malfunctions in the trailer socket or any other part of the trailer electrical equipment!

Depending on the type of trailer module used in this electric kit, diagnostic interrogation with the vehicle's electrical system may be limited or will not function. The error memory inside the trailer module may not be able to be accessed by vehicle manufacturers diagnostic system.

Error logs relating to the trailer electrical equipment, that may be generated in the vehicle manufacturers diagnostic system as a result of a test procedure, may be due to the incorrect installation of the towing electric kit or the false activation of the trailer module.

**We always recommend whenever possible, the following troubleshooting process:**

→ An analysis of the vehicle's error memory and possibly clearing of all faults before the start of the installation!

→ Try disconnecting the trailer module from the towing harness and re-start the fault clearing process!

→ If in doubt, limit the time for troubleshooting to a max of 0,5 hours and call our Technical Support Team!

Please follow our instructions carefully and always test the towing electrics using a true lighting board or a specifically designed bulb tester. If an LED tester is used, ensure it is equipped with correct load resistors or malfunctions will occur!

This instruction is subject to changes and we reserve the right to make changes to design, colour etc.

All of the data and illustrations may not be an exact representation but the text contained in this instruction must be observed!

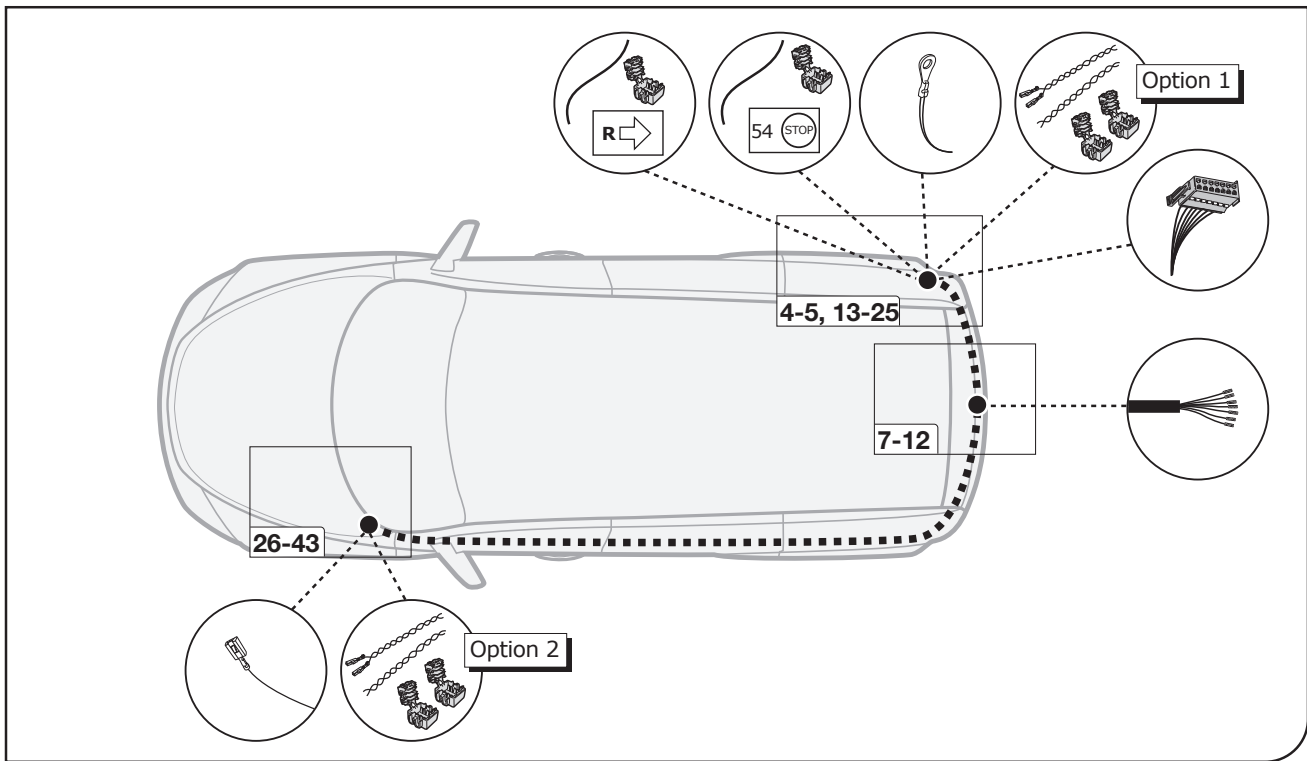
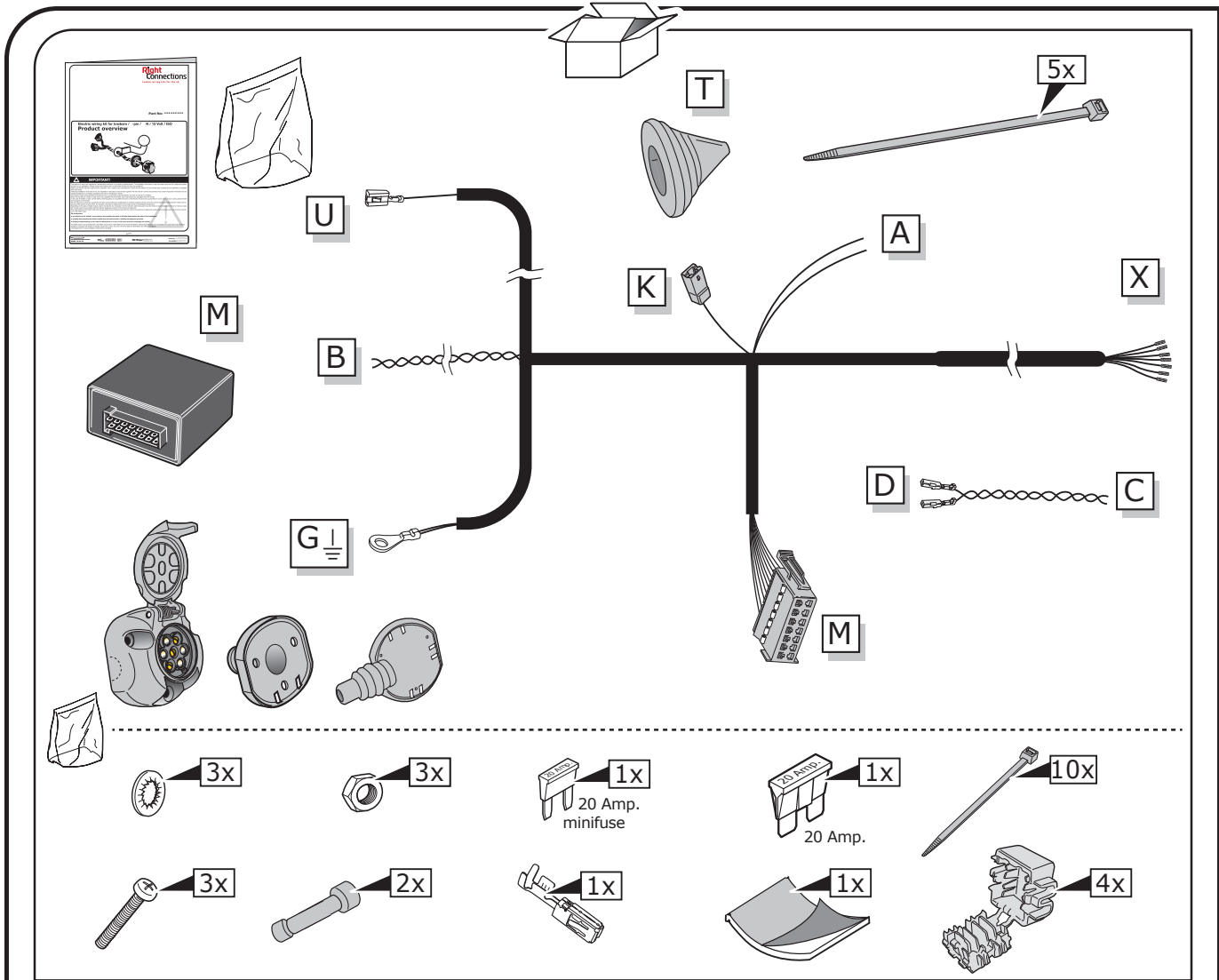

## SYMBOL EXPLANATION

	Left (58-L) respectively Right (58-R) tail light
54	Stop light (54) / high mounted, third stop light (54)
	Turn signal indicator left
	Turn signal indicator right
	Rear fog light(s)
	Reversing light(s)
	Permanent power supply / 13pin socket, chamber 9
	Charging wire for trailer battery / 13pin socket, chamber 10
	Trailer / trailer recognition
<b>B+ / 30</b>	Permanent current power supply
	Ground or Earth (31)
	Ground connection battery terminal lug
	Positive connection battery terminal lug

	12V	Cigarette lighter / accessory socket
		Loudspeaker / buzzer
		Park Distance Control
		Switch / source of function
		Connect together
		Disconnect
		Look at / See further information
		Look carefully at selected area
		Present / Occupied / OK
		Not present / Not occupied / Not OK
		Acoustic indication
		Attention / important advice
	20 Amp.	Fuse / fuse capacity 20 Ampère

## TOOLS

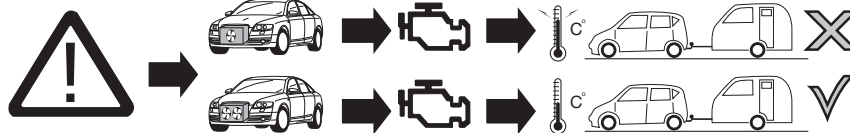
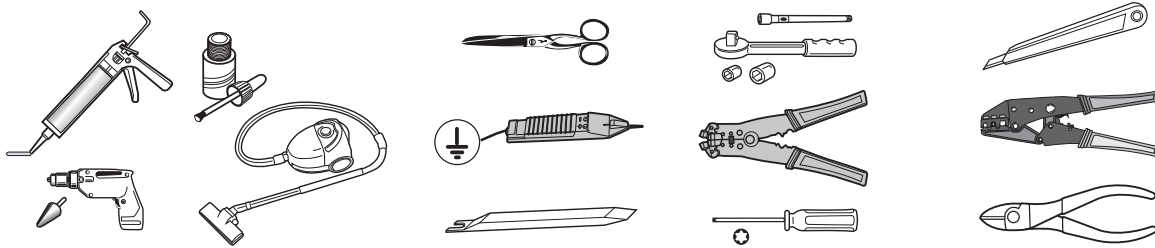

### ATTENTION!

The vehicle's cooling capacity may have to be increased when retrofitting a trailer coupling!  
You must observe the manufacturer's instructions!!

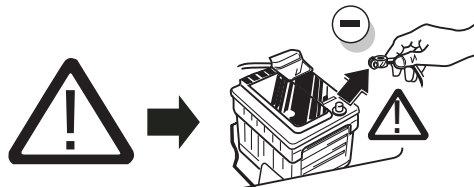

Note: It may be necessary to check if this vehicle has a stored radio code before disconnecting the battery!



### ATTENTION!

In order to avoid mal-functions and damage to the vehicle's electrical system the earth terminal **must be disconnected** from the vehicle's battery **before starting work!**

Both the trailer module and the vehicle's control unit for the electrical system can be damaged during work on the data bus connections if the battery is not disconnected!

1

Please pay attention to the manufacturer's instructions when disconnecting and reconnecting the vehicle's battery!

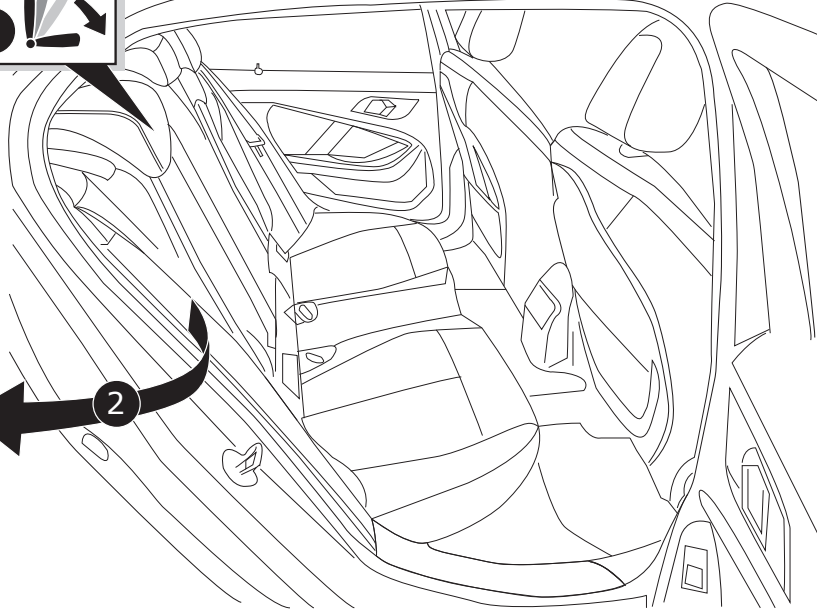
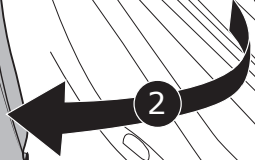
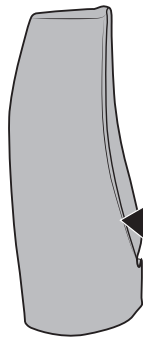

2

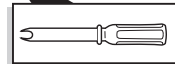
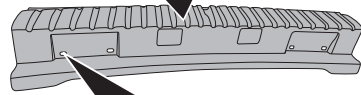
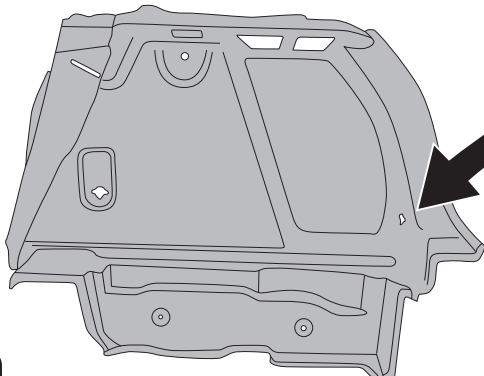
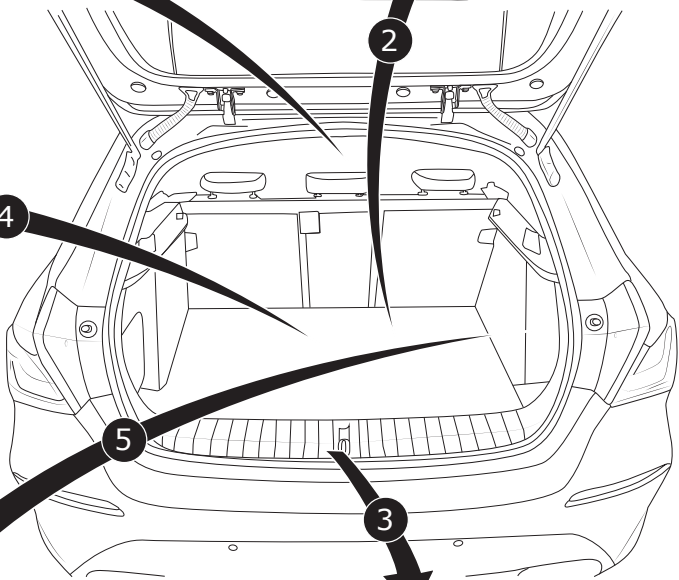
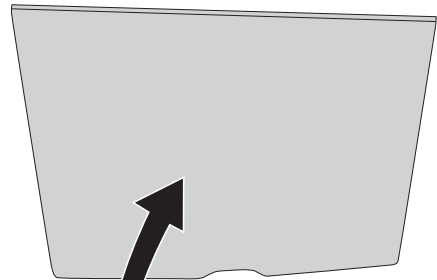
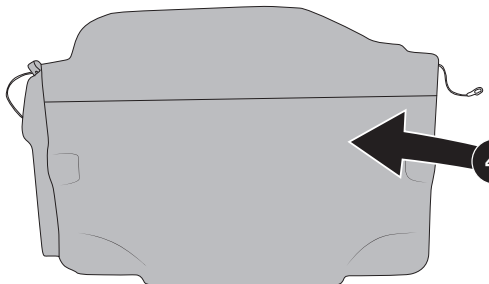
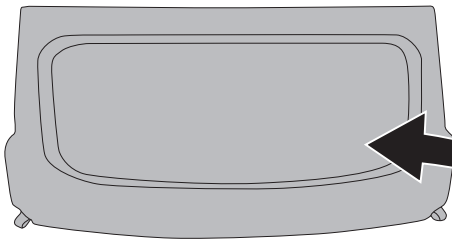

3

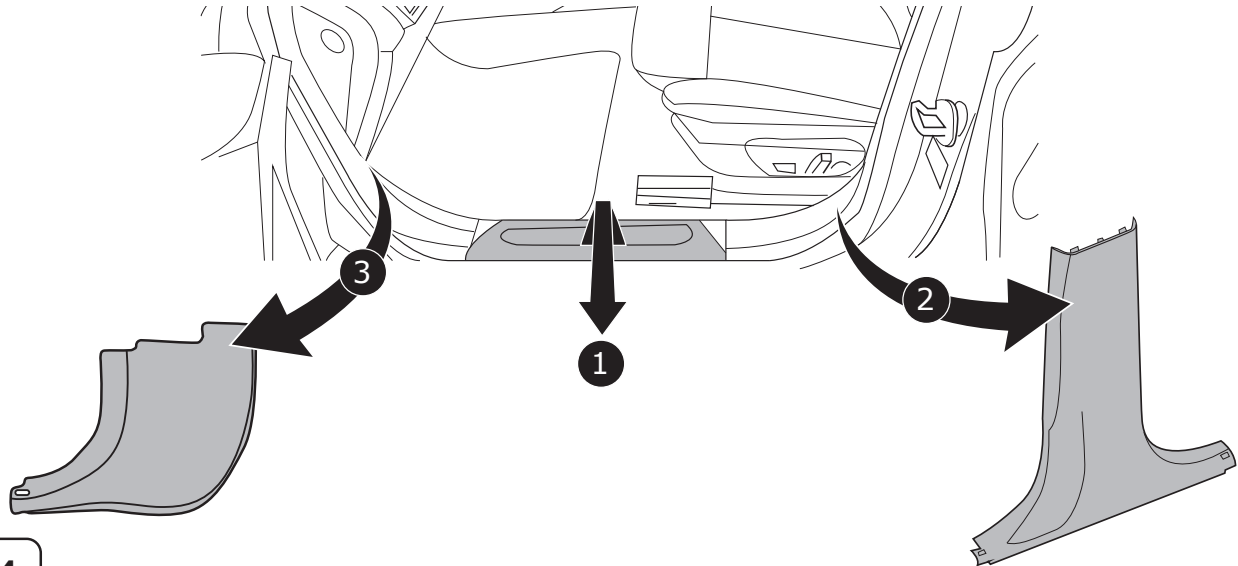

4

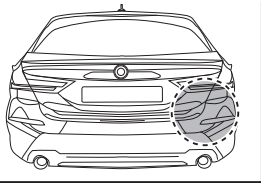

**Option 1**

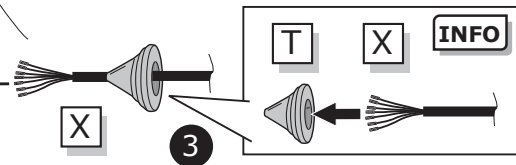
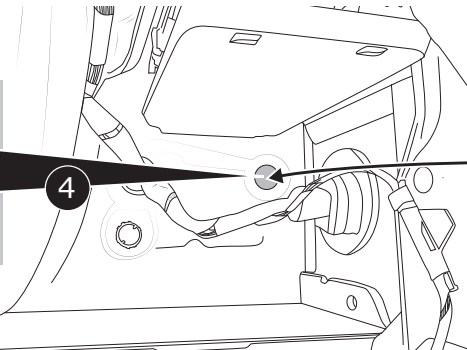
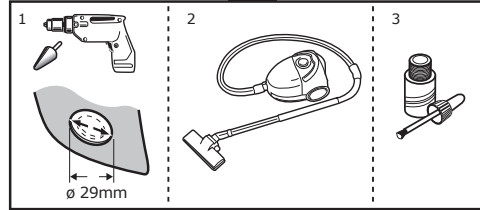
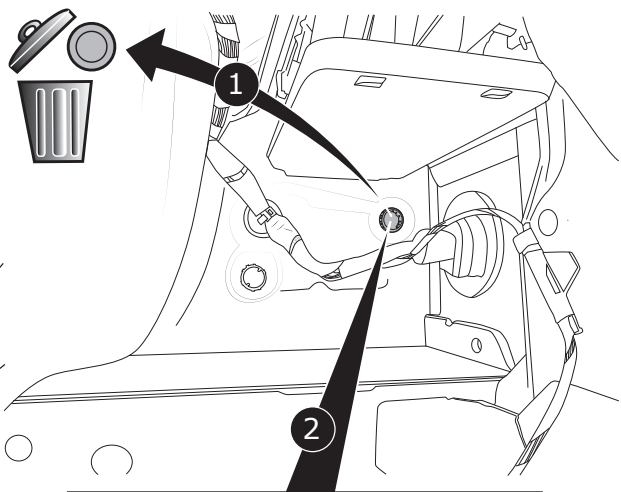
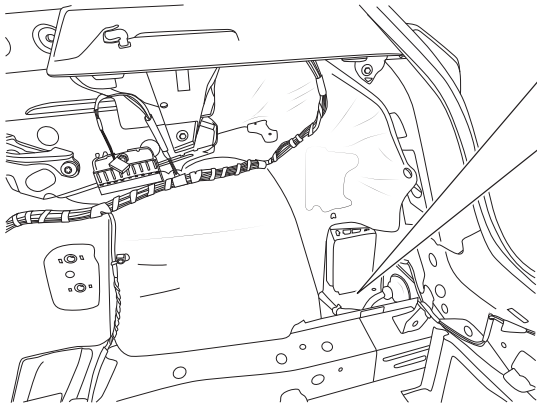

5

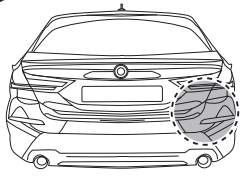

**Option 2**

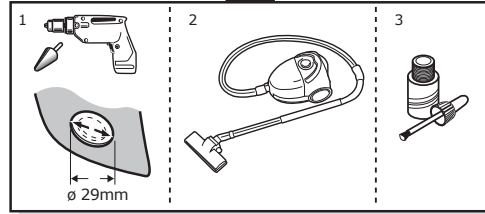
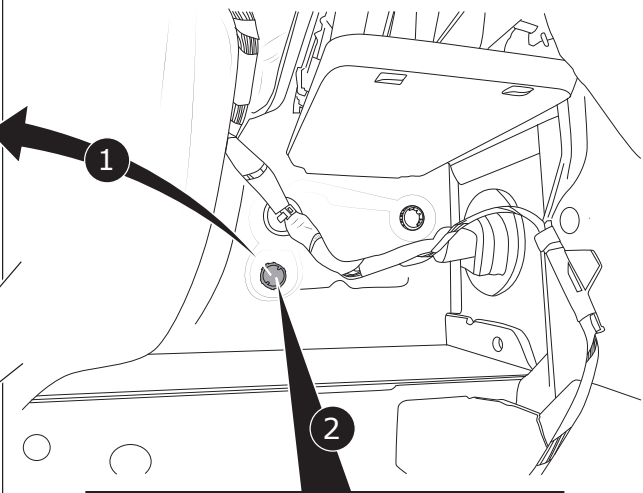
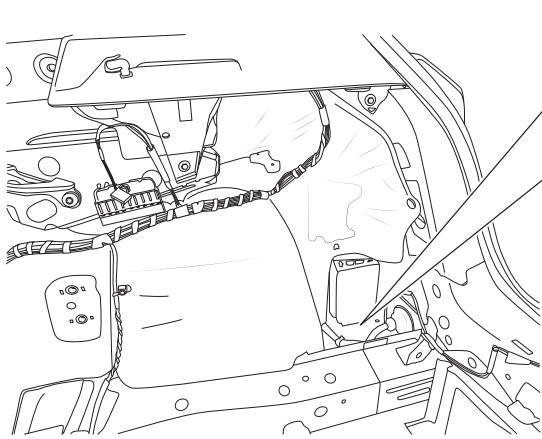

4

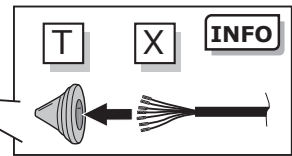
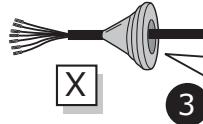
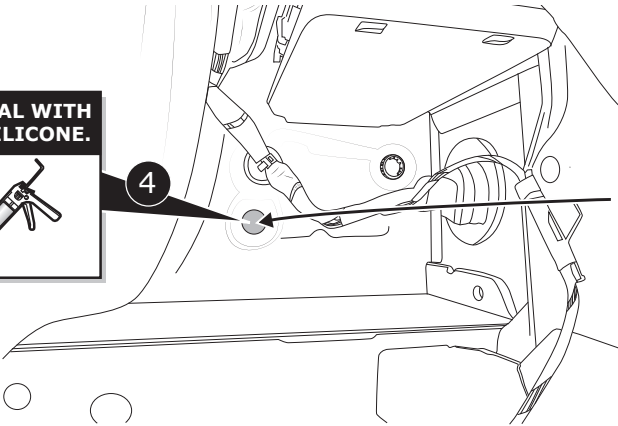

6

7

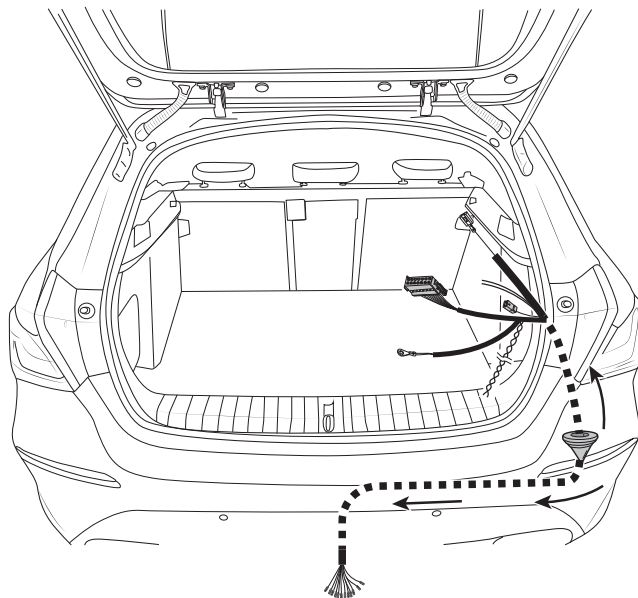



Option 1

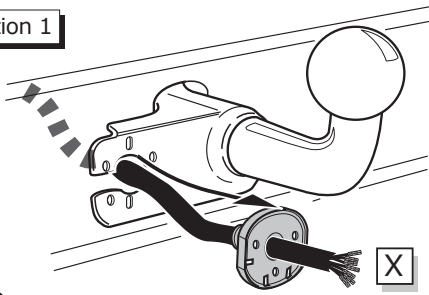

8

Option 2

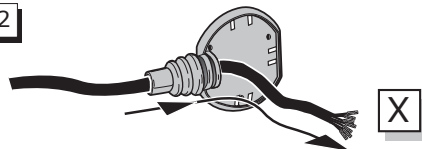

Option 3

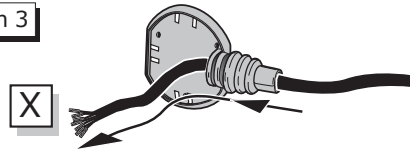

SOCKET CONNECTION

DIN/ISO 1724	←L	⊕	⊖ 1-7	R→	☀	STOP	☀
	1/L	2	3/31	4/R	5/58-R	6/54	7/58-L
Pmax	21W	21W		21W	42W	3x21W	42W
	Yellow	Blue	White	Green	Brown	Red	Black

9

Option 1

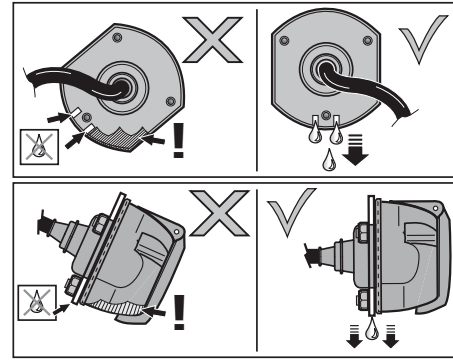
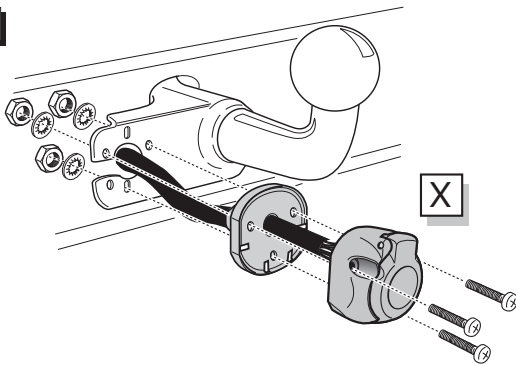

10

Option 2

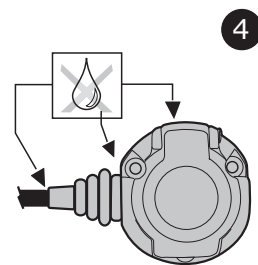
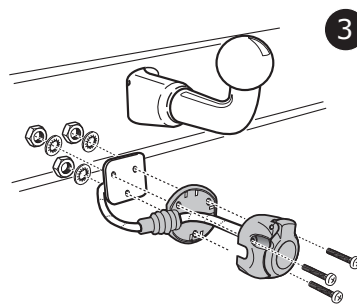
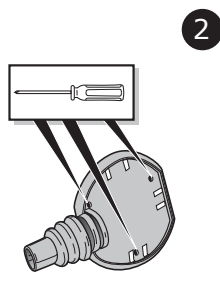
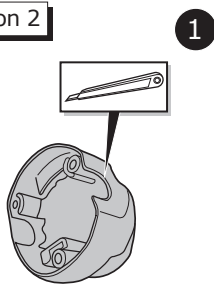

11

Option 3

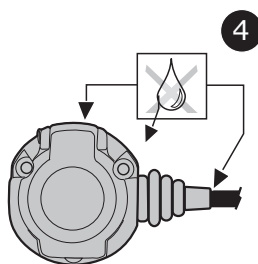
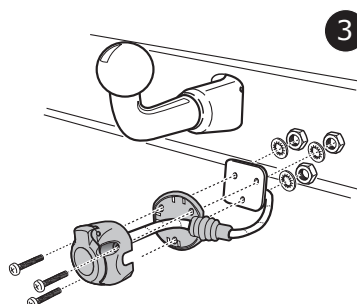
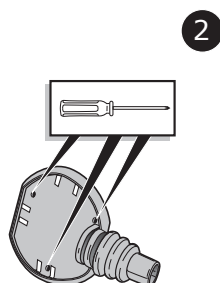
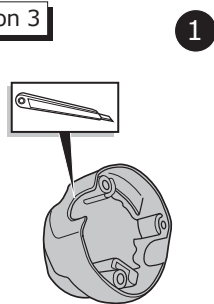

12

13

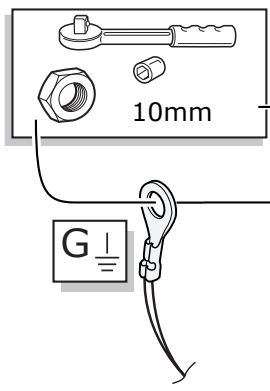
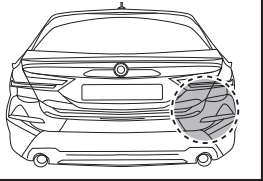
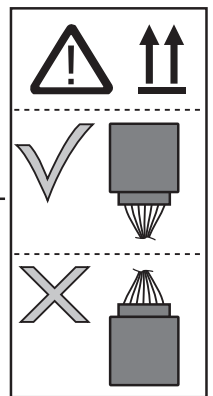
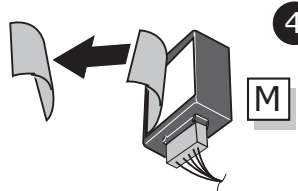
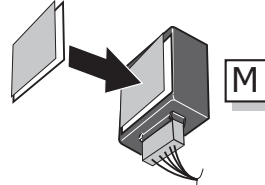
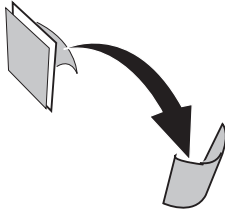
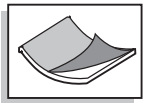
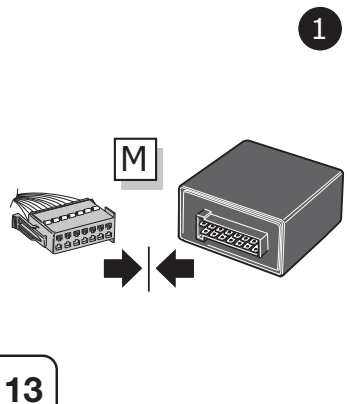

1

2

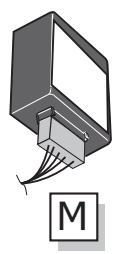
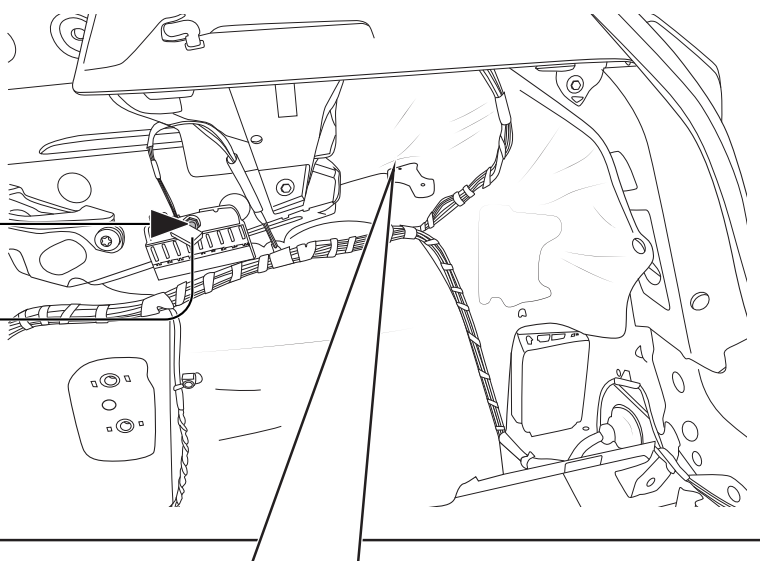

4

3

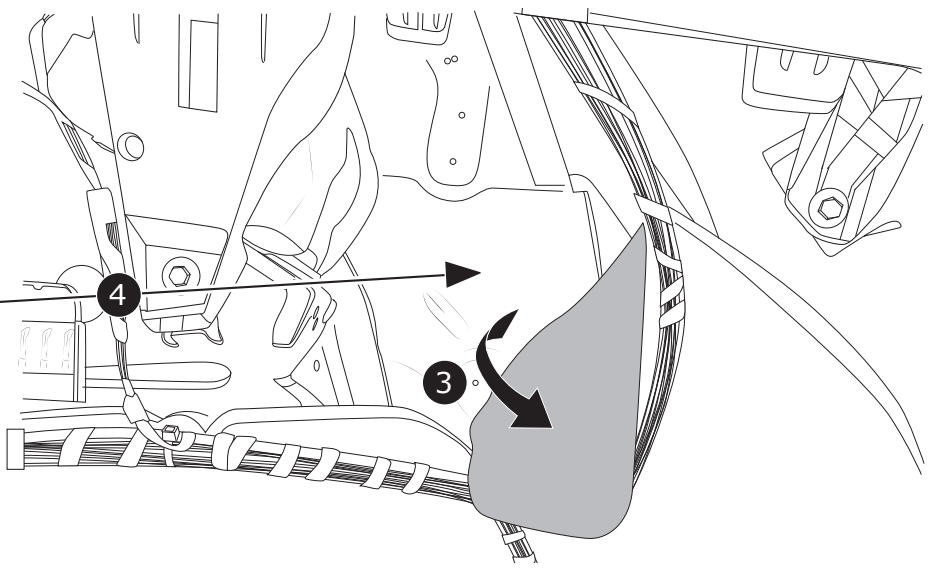

14



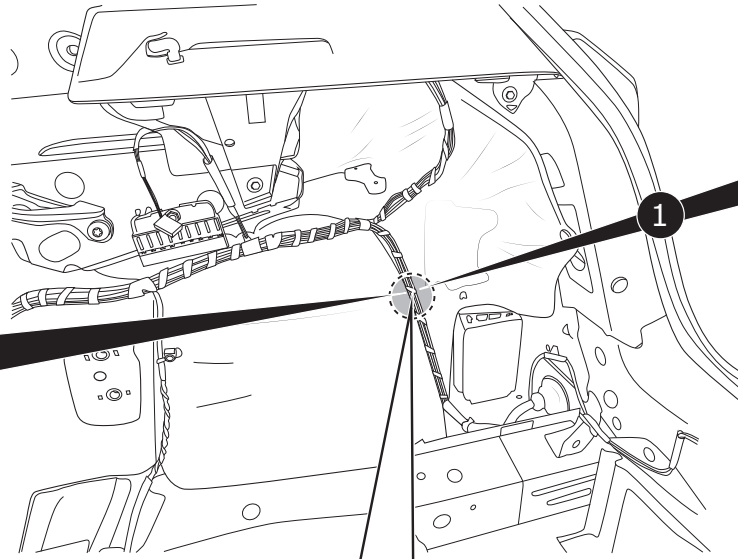
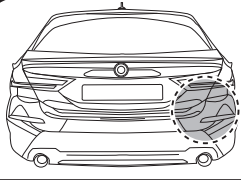

1 Remove tape

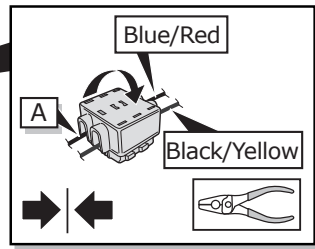
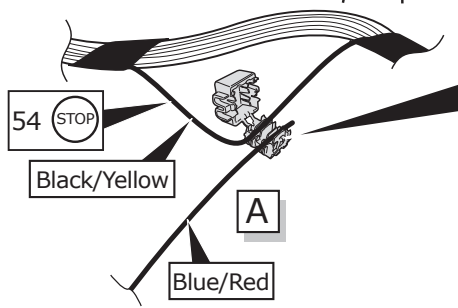
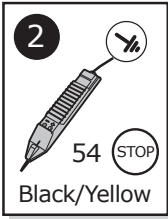

3

15

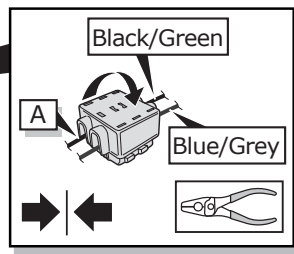
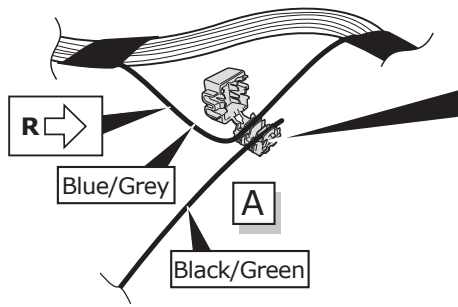
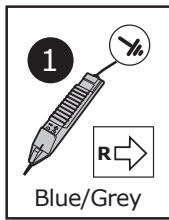
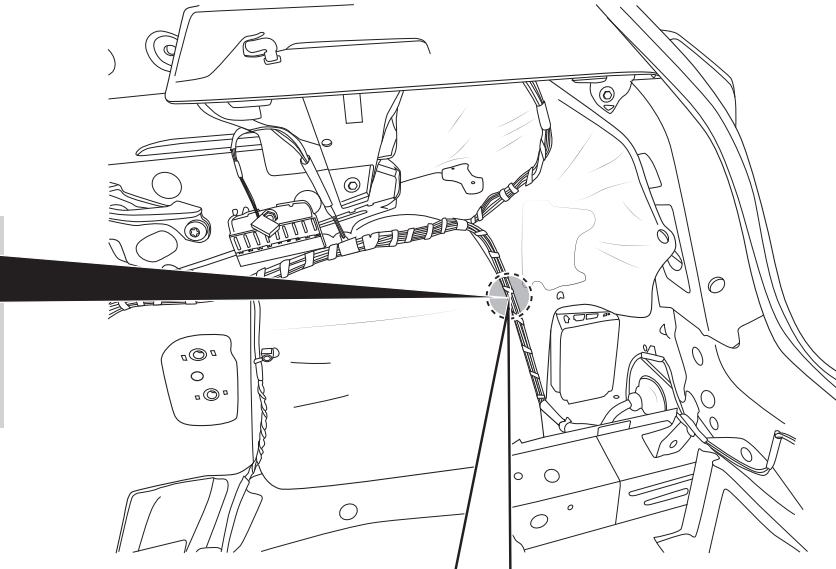
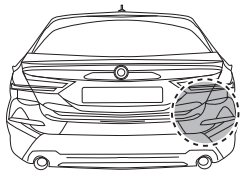

2

16

**CAN-Data Wire**

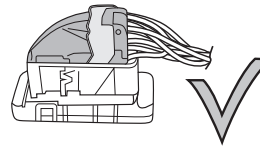
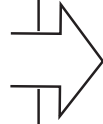
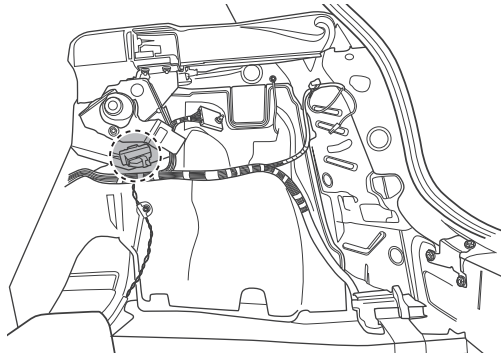
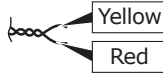

**Option 1**

18 - 25

34 - 52



**Option 2**

26 - 52



Important!

Please note informations in picture 1!

17

**Option 1**

Black

Yellow

B

Cut to length!

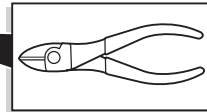

18

**Option 1a**

Black

Black

C

B

Yellow

Yellow

D

1

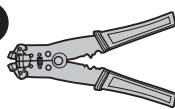

2

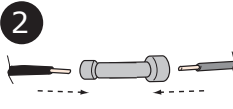

3

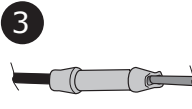

4

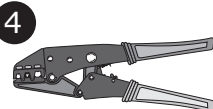

19

Option 1a

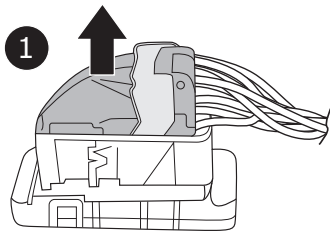

CAN-Data Wire

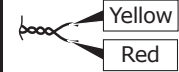

Important!  
Please note informations in picture 1!



20

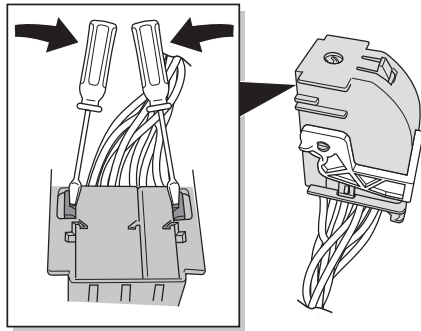

2

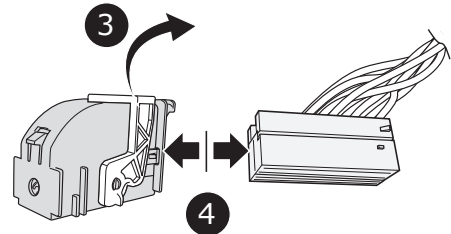

Option 1a

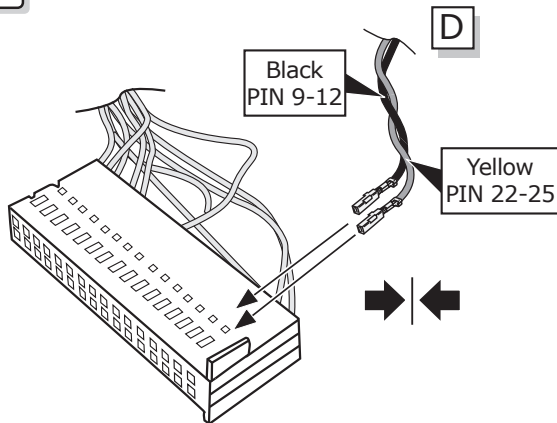

CAN-Data Wire

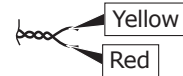

Important!  
Please note informations in picture 1!

21

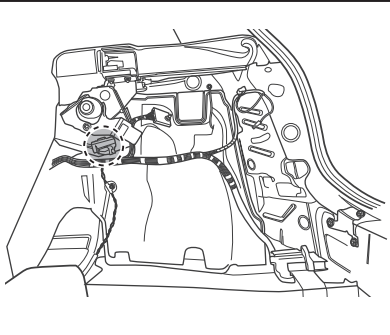

Option 1a

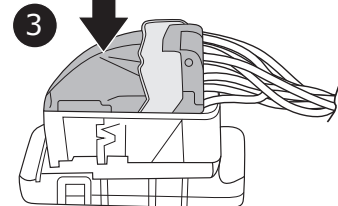
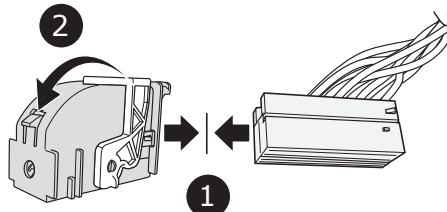

22

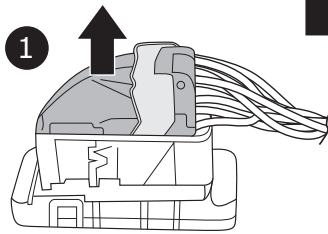
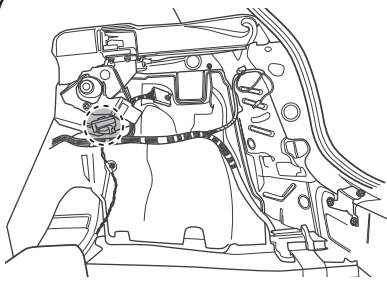

**CAN-Data Wire**

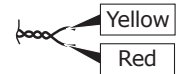

Important!  
Please note informations in picture 1!



**Option 1b**

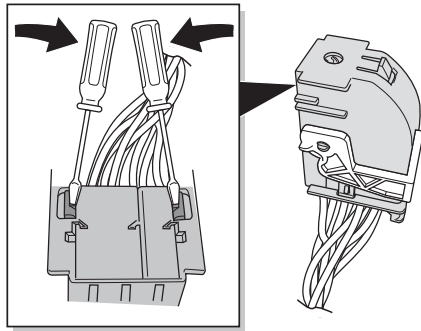

2

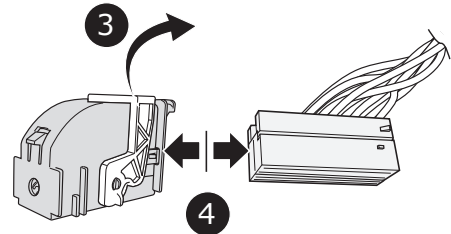

23

**Option 1b**



Important!  
Please note informations in picture 1!

**CAN-Data Wire**

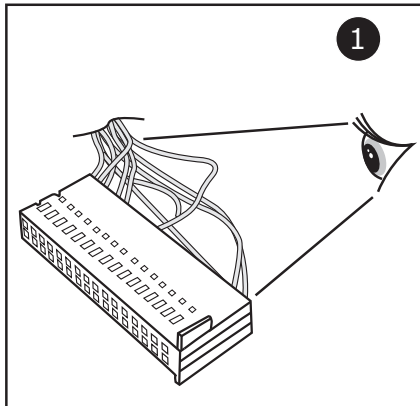
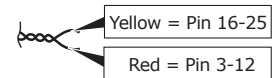

1

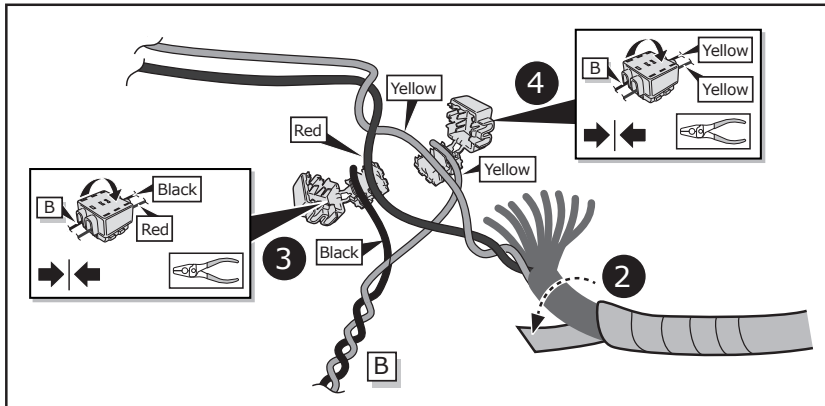

24

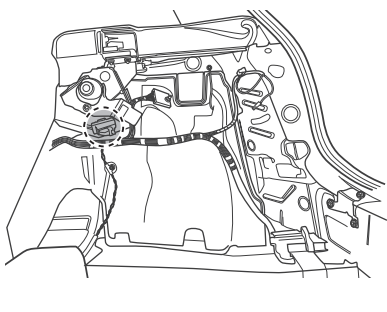

**Option 1b**

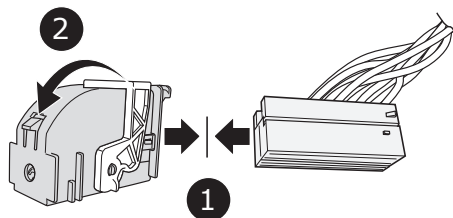

2

1

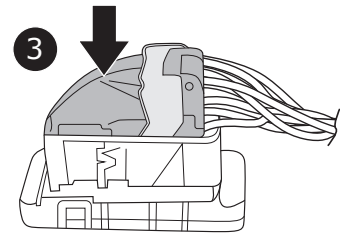

3



25

**Option 2**

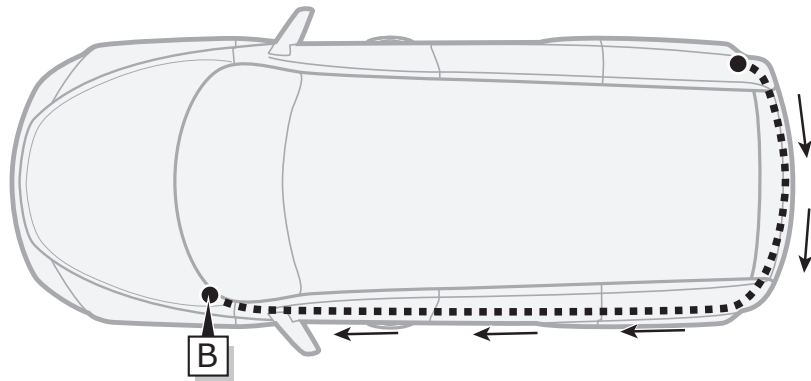

26

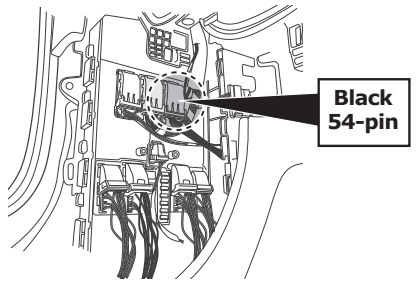

**Option 2a+2b**



Important!  
Please note informations  
in picture 1!

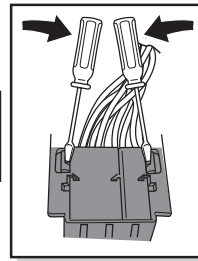

1

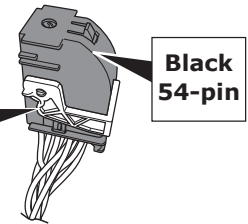

**Black 54-pin**

**CAN-Data Wire**

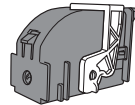
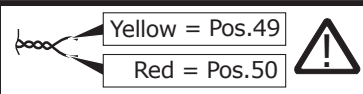

2

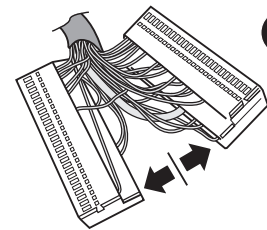

3

27

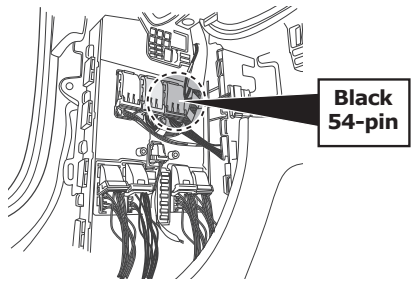

**Option 2a**



Important!  
Please note informations  
in picture 1!

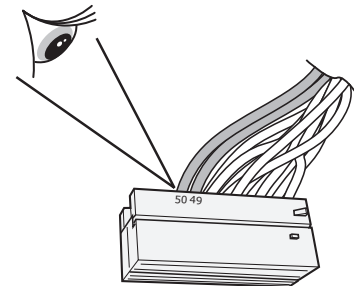

1

**CAN-Data Wire**

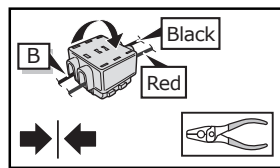
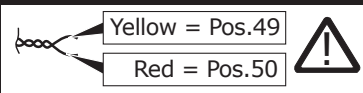

3

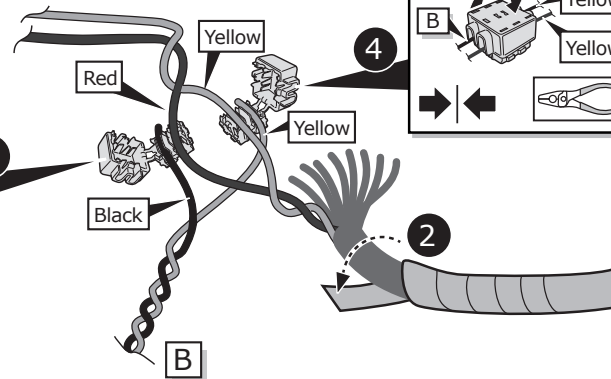

4

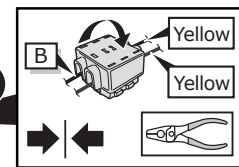

28

**Option 2b**

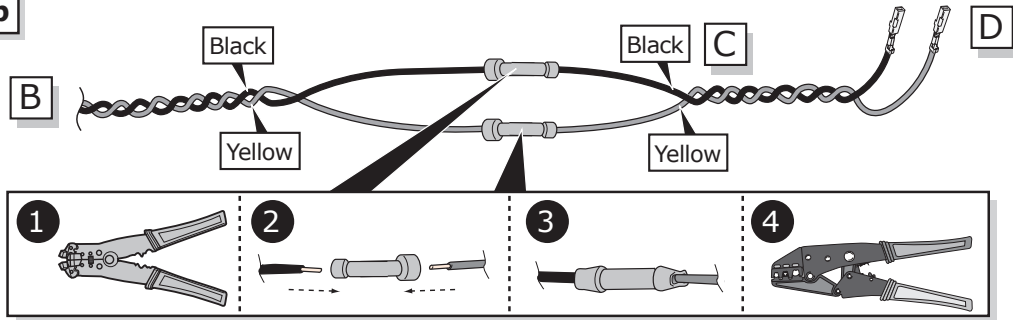

29

**Option 2b**

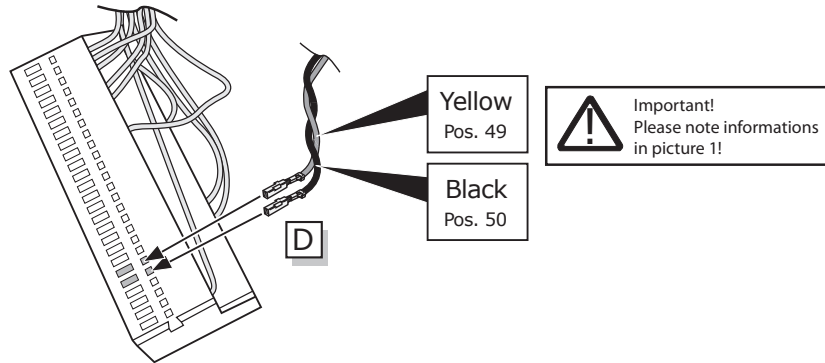

30

**Option 2a+2b**

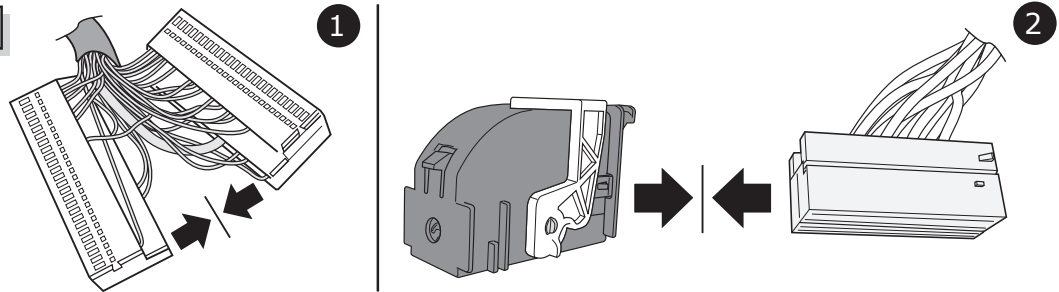

31

**Option 2c Low Spec Cars:**

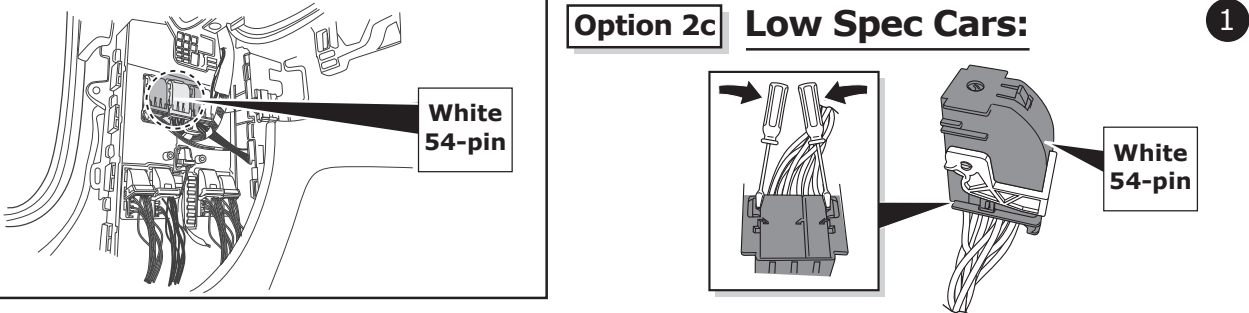

**CAN-Data Wire**

Blue = Pos.36  
Red = Pos.35

**Important!**  
Please note informations  
in picture 1!

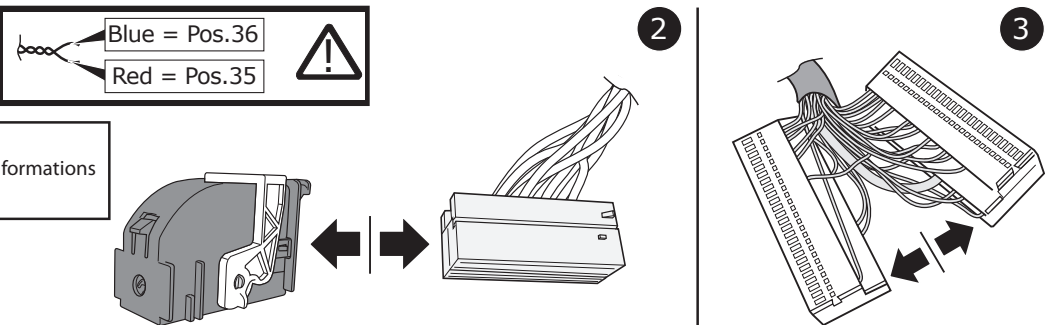

32



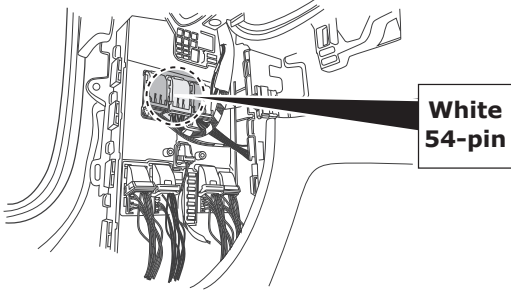

**Option 2c Low Spec Cars:**

**1**

**!** Important!  
Please note informations  
in picture 1!

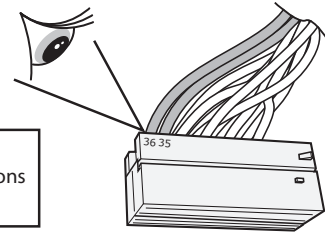

**CAN-Data Wire**

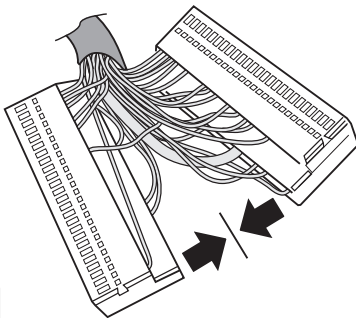
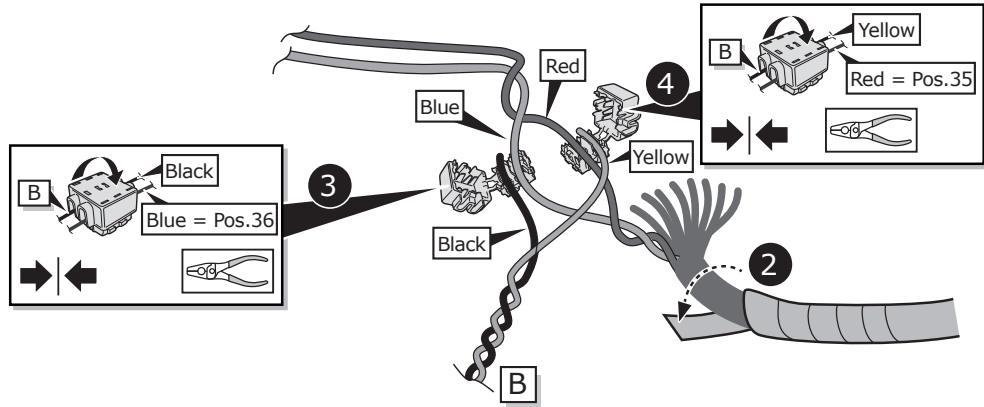
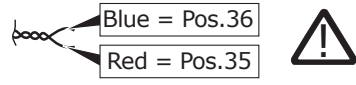

**5**

**33**

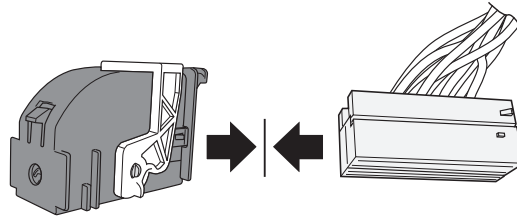

**6**

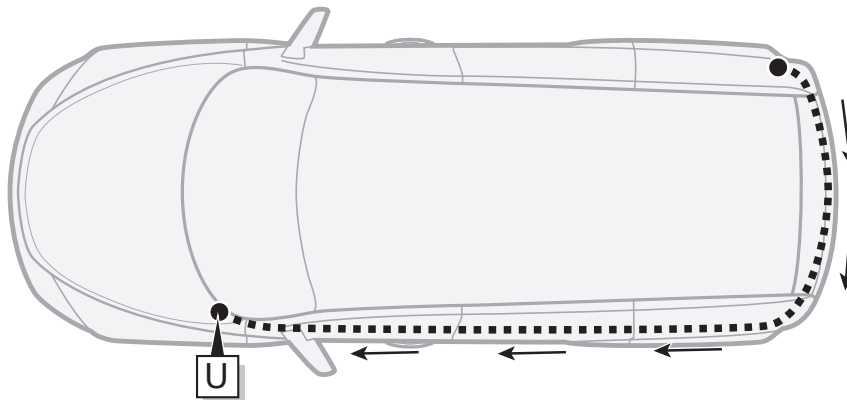

**34**

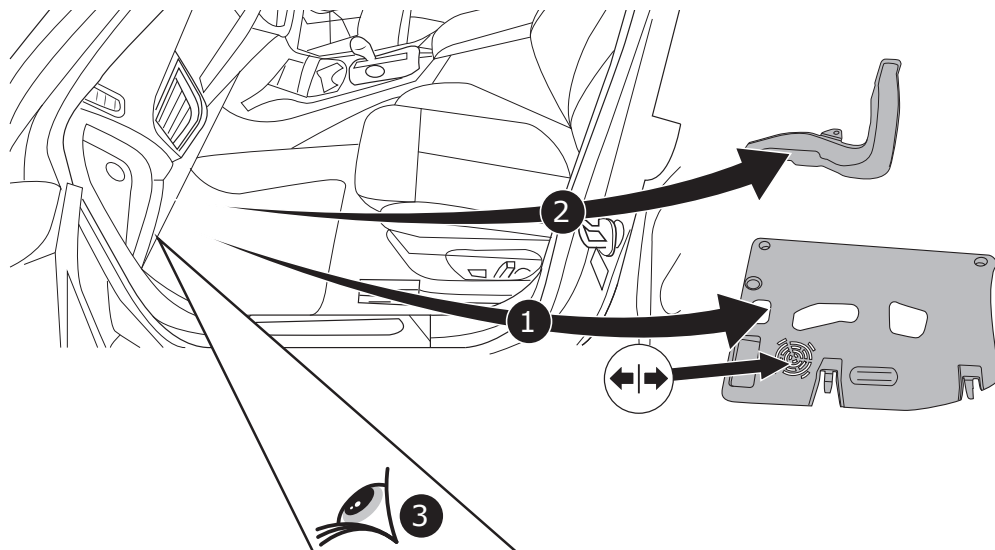

**Option 1**

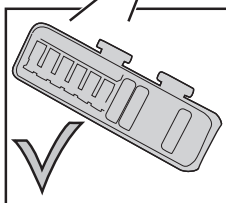
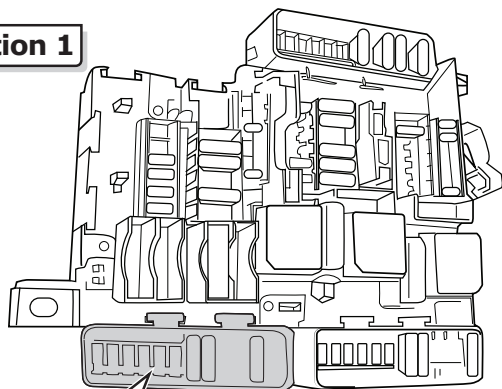

35

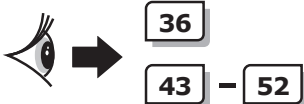

**Option 2**

**Option 3**

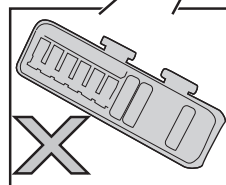
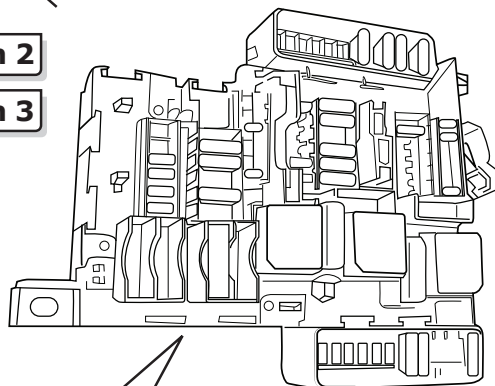

**Option 1**

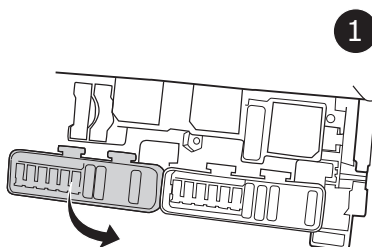

**Red / Blue**  
Choose a free space  
Chamber 103-108

U

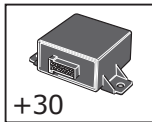
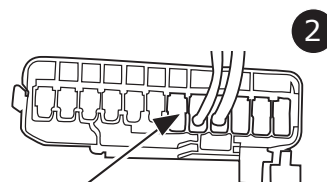

36

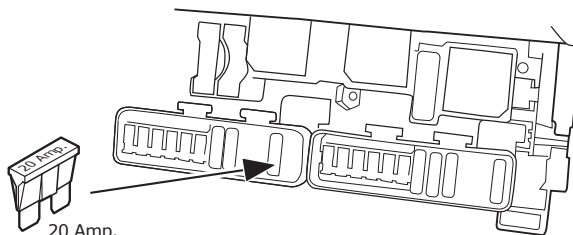
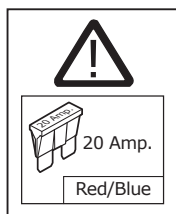



Option 2

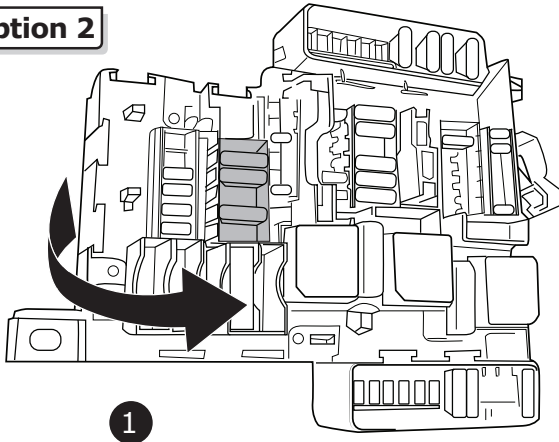

37

Disengage secondary lock

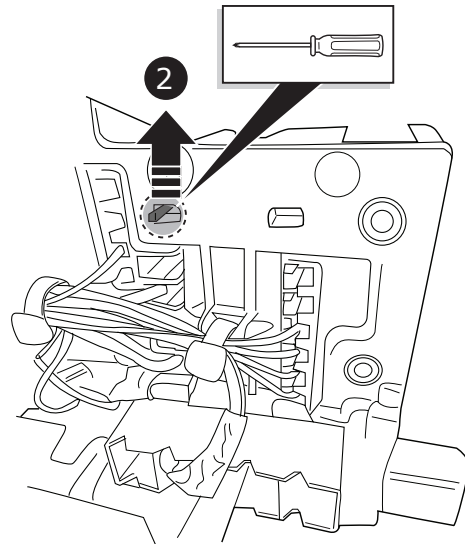

Option 2

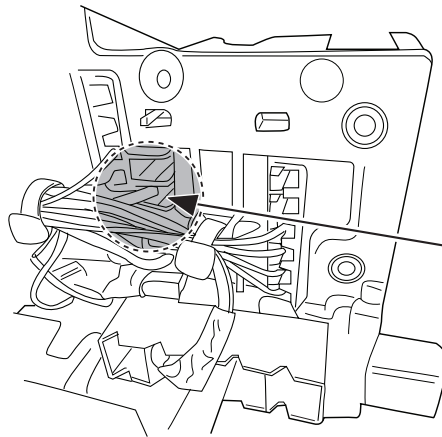

Red/Blue  
Choose a free space  
Chamber 43-48

U

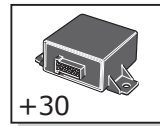

1

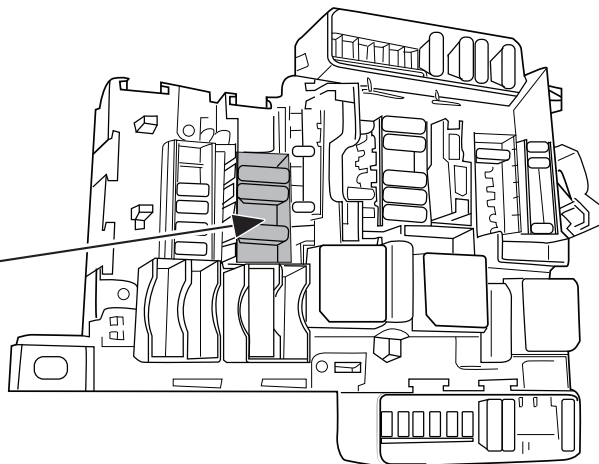
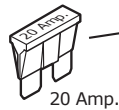
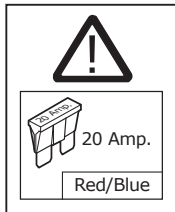

2

38



Option 3

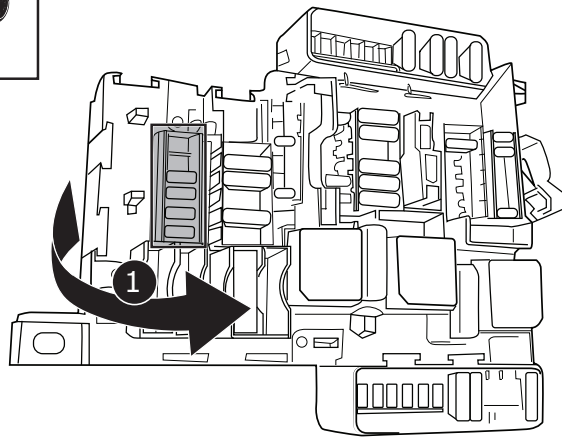

39

Disengage secondary lock

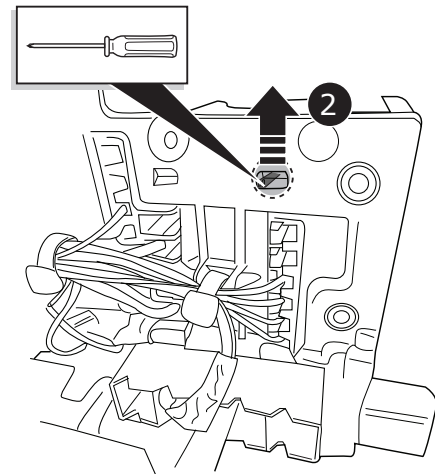

Option 3

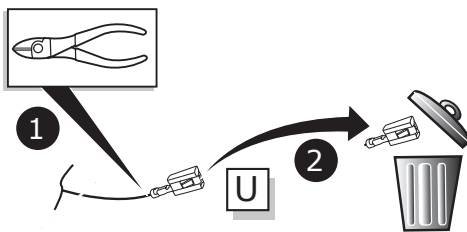

40

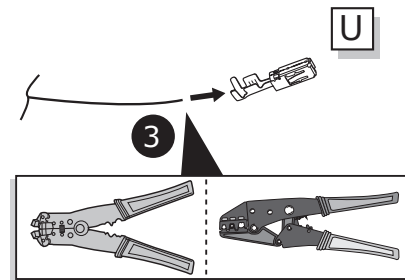

Option 3

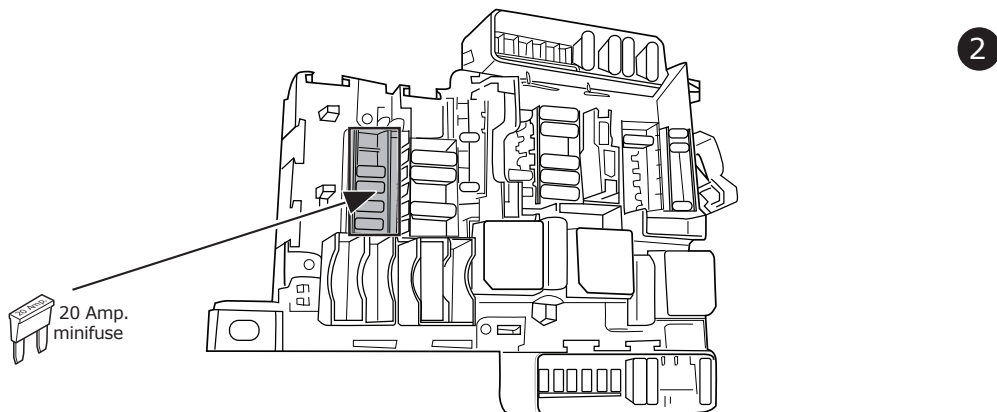
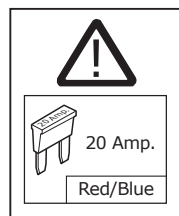
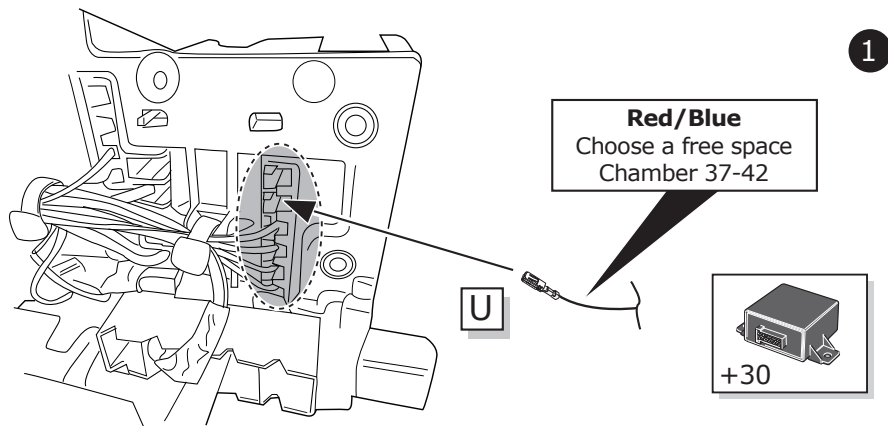

41

**Option 2 + 3**

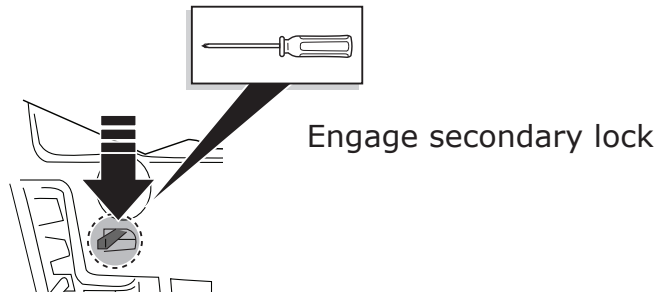

42



Please note the new fuse positions !!

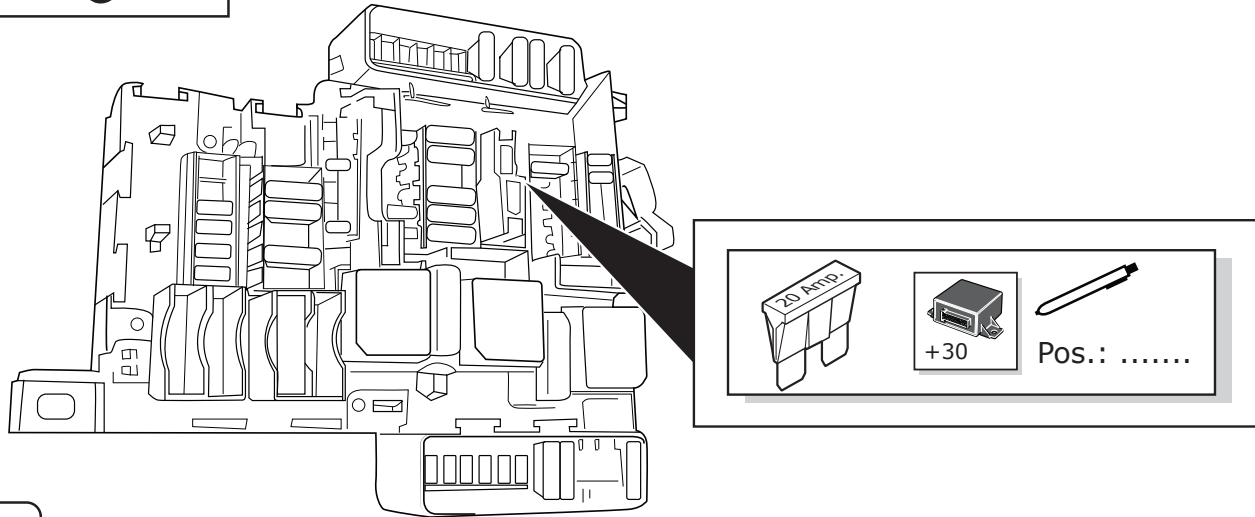

43

**Optional**

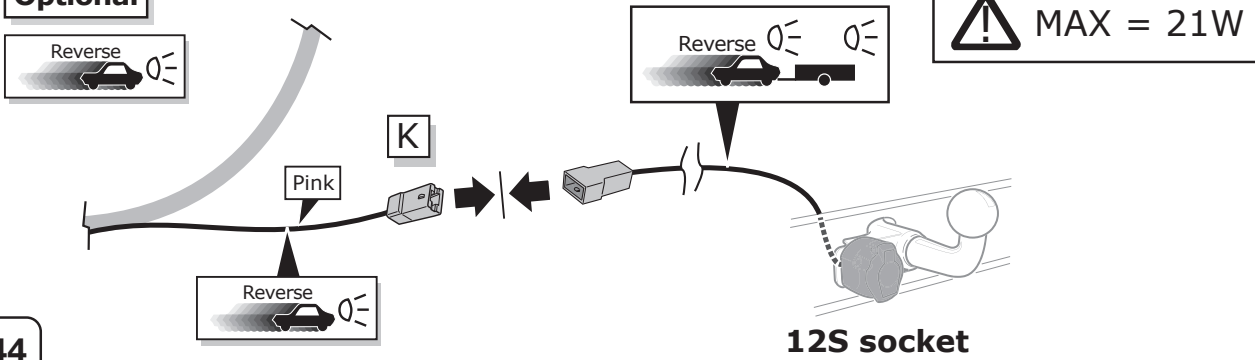

44

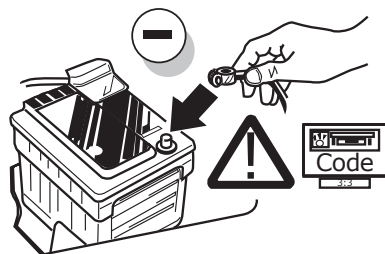

45

**Optional**

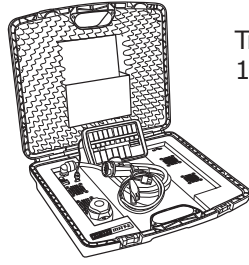

Trailer Simulator for 7- and 13-pin Sockets

46

**Functional test**

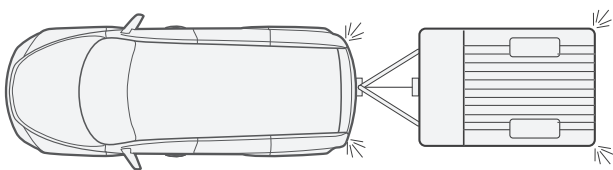
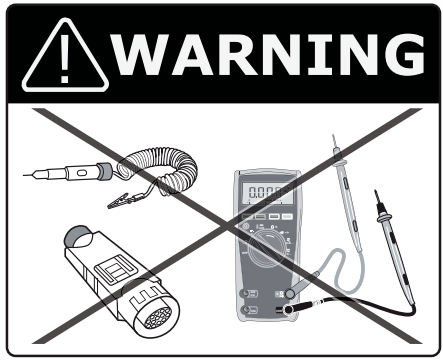
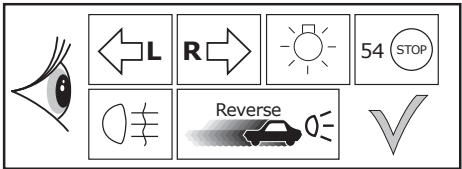

**LIGHT MATE**

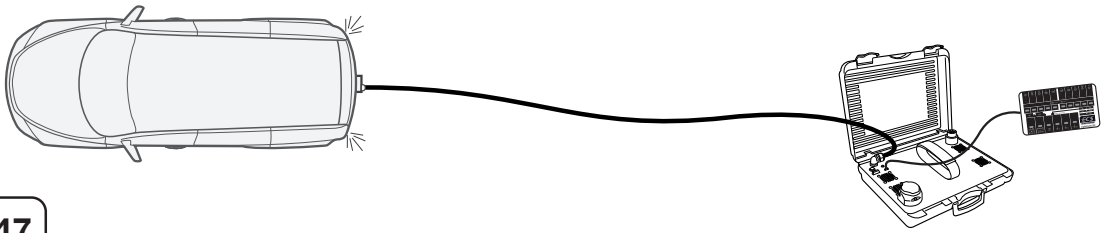

47

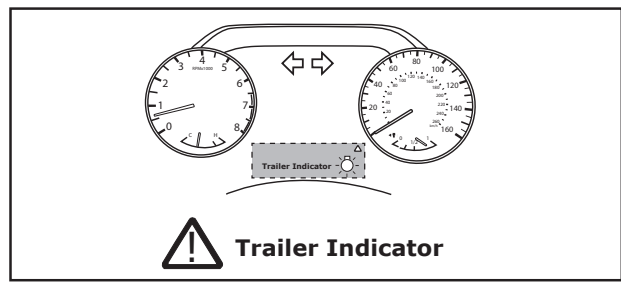
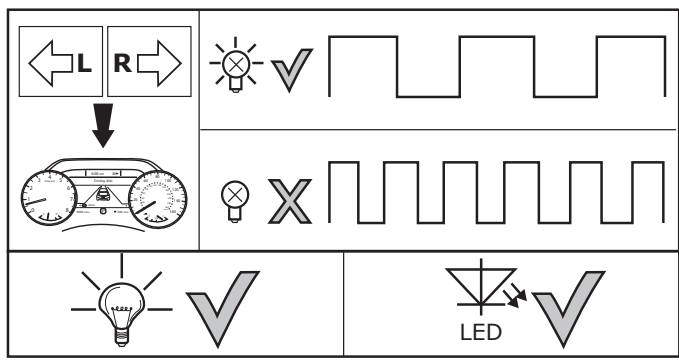
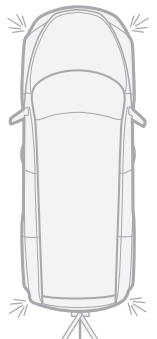

48



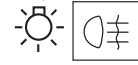
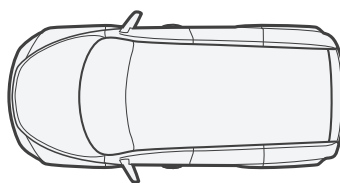
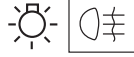
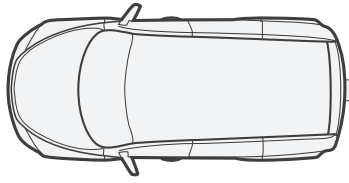

49

**Optional**

**Adapter socket**

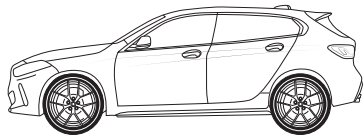

7-pin

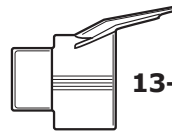

13-pin

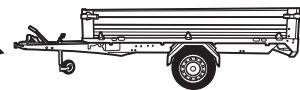

50

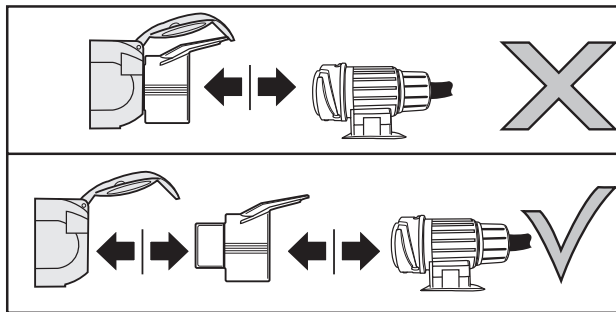
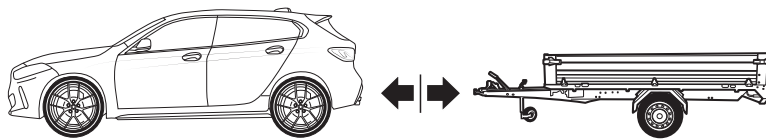

51

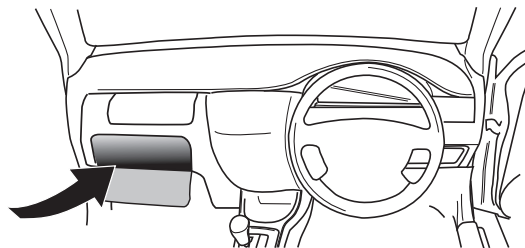

52